

MVE 50/1

Performance data

- 6-pole motor, rated speed: 1000 rpm
- Standard: 400V / 50 Hz, 3-phase
- ATEX II 2D Ex tb IIIC Tx Db IP66
- Start-up possible in any position



Type	Working moment	Unbalance force	Performance	Max. current	Weight
	[kgcm]	[kN]	[kW]	[A]	[kg]
MVE 50/1	9,49	0,52	0,12	0,40	10,40

Table 1: Performance data (at 400V / 50 Hz)

Dimensions

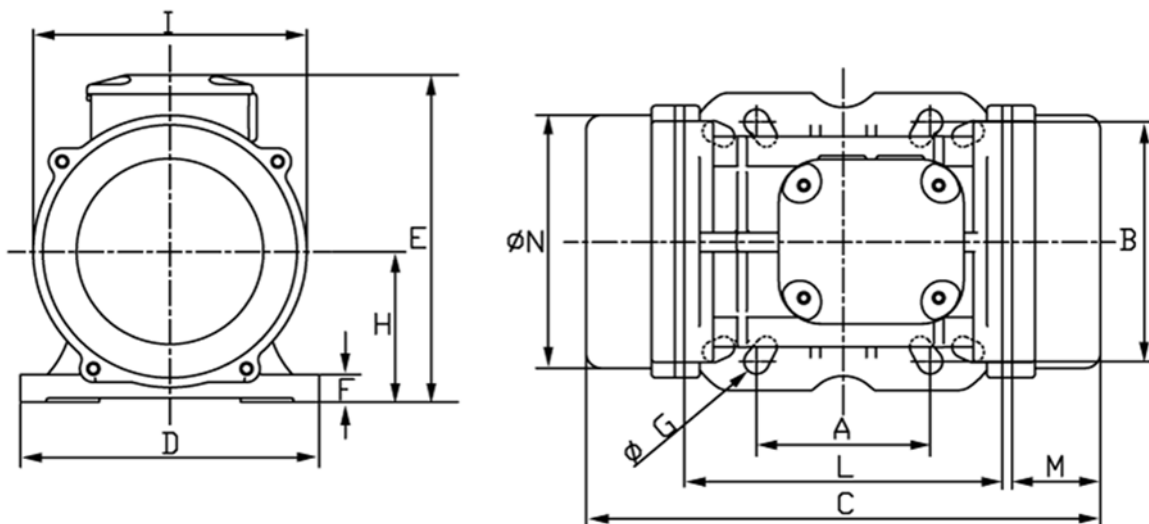

Dimension	A	B	C	D	E	F	G	H	I	L	M	N	Screw
	[mm]	[mm]	[mm]	[mm]	[mm]	[mm]	[mm]	[mm]	[mm]	[mm]	[mm]	[mm]	
MVE 50/1	80	110	273	154	175	15	11	79	142	163	55	131	M10
	90	125					13						M12
	124	110					11						M10
	135	115					11						M10

Table 2: Dimensions