

Micro 41-3

Leistungsdaten

- 2-poliger Motor, Nenndrehzahl: 3000 U/min
- Spannung 400V / 50 Hz, 3-Phasen
- ATEX II 2D Ex tb IIIC Tx Db IP66
- Anlauf in jeder Position möglich



Typ	Arbeitsmoment	Unwuchtkraft	Leistung	max. Strom	Gewicht
	[kgcm]	[N]	[kW]	[A]	[kg]
Micro 41/3	0,90	441	0,06	0,18	2,4

Tabelle 1: Leistungsdaten (bei 400V / 50 Hz)

Abmessungen

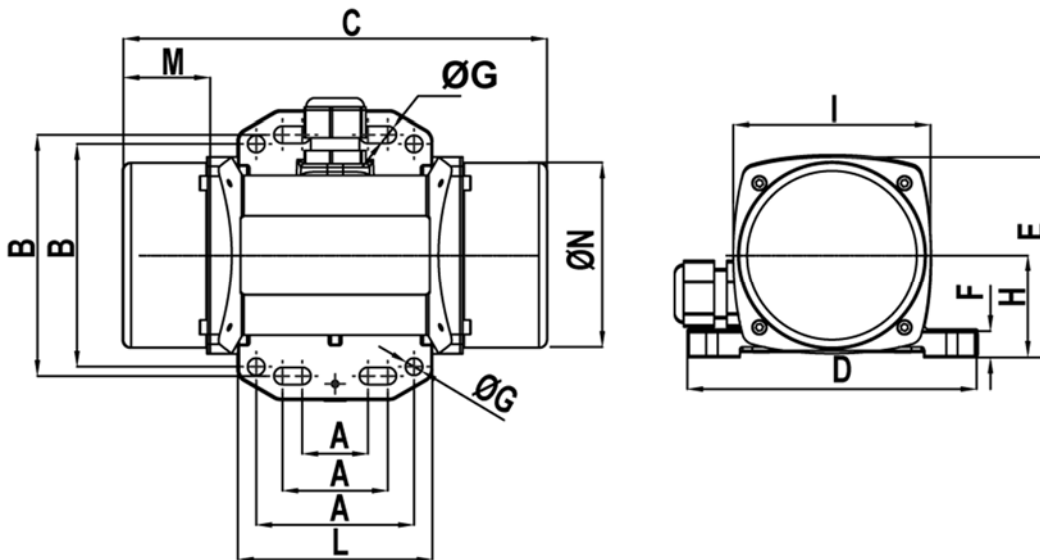

Maß	A	B	C	D	E	F	G	H	I	L	M	N
	[mm]	[mm]	[mm]	[mm]	[mm]	[mm]	[mm]	[mm]	[mm]	[mm]	[mm]	[mm]
Micro 41/3	25-40	92	161	110	76,5	10	6,5	39	75	74	37	70,5
	60	85										

Tabelle 2: Abmessungen