

# S13

## Performance data

- The vibrations are generated by a ball guided in a hardened steel ring in an epicyclic motion
- Operating temperatures -20°C bis +200°C
- Start-up possible in any position
- A 3/2 way valve and filtered compressed air are required for operation
- Vibration frequency and force are adjusted via the operating pressure (up to 6 bar)
- ATEX Zone 21 II 2D c T95°C/135°C/200°C/210°C  
 Zone 1 II 2G c T5/T4/T3/T2



Typ	Rotation speed [1/min]			UnbalancedForce [kN]			Air consumption [l/min]		
	2 bar	4 bar	6 bar	2 bar	4 bar	6 bar	2 bar	4 bar	6 bar
S13	15.000	18.500	22.500	0,31	0,54	0,85	94	158	225

Table 1: Performance data

## Dimensions

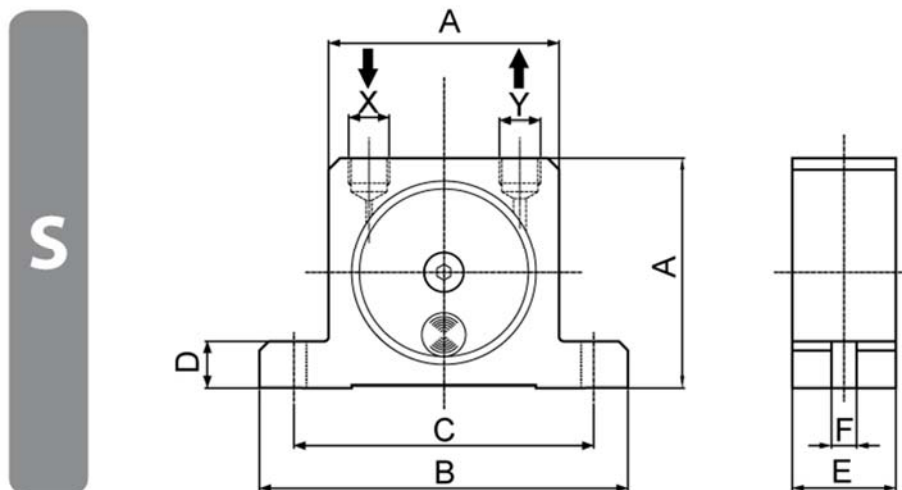

Typ	A	B	C	D	E	F	X-Y	Weight
	[mm]	[mm]	[mm]	[mm]	[mm]	[mm]		[kg]
S13	65	113	90	16	25	9	1/4"	0,26

Table 2: Dimensions