

OT16

Performance data

- The vibrations are compensated for by an unbalanced masses turbine, which is mounted in special ball bearings.
- Operating temperatures -20°C bis +120°C
- Start-up possible in any position
- A 3/2 way valve and filtered compressed air are required for operation
- Vibration frequency and force are adjusted via the operating pressure (up to 6 bar)
- ATEX Zone 21 II 2D c T95°C/125°C
Zone 1 II 2G c T5/T4



Typ	Rotation speed [1/min]			UnbalancedForce [kN]			Air consumption [l/min]		
	2 bar	4 bar	6 bar	2 bar	4 bar	6 bar	2 bar	4 bar	6 bar
OT16	18.000	20.000	21.000	1,90	2,34	2,59	122	204	285

Table 1: Performance data

Dimensions

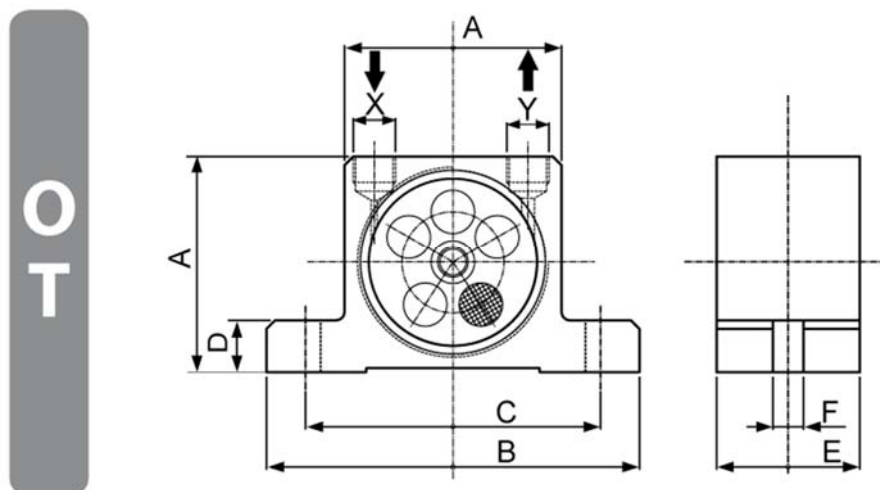

Typ	A	B	C	D	E	F	X-Y	Weight
	[mm]	[mm]	[mm]	[mm]	[mm]	[mm]		[kg]
OT16	65	113	90	16	42	9	1/4"	0,58

Table 2: Dimensions