

ER-A-900-15

Leistungsdaten

- 4-poliger Motor, Nenndrehzahl: 1500 U/min
- Standard: 400V / 50 Hz, 3-Phasen
- Anlauf in jeder Position möglich
- ATEX ExII2D



Typ	Arbeitsmoment		Unwuchtkraft		Leistung	max. Strom	Gewicht
	[kgcm]	[kN]	[kg]	[kW]	[A]	[kg]	
ER-A-900-15	71,4	8,83	900	0,90	0,92	30,0	

Tabelle 1: Leistungsdaten (bei 400V / 50 Hz)

Abmessungen

Abb. A

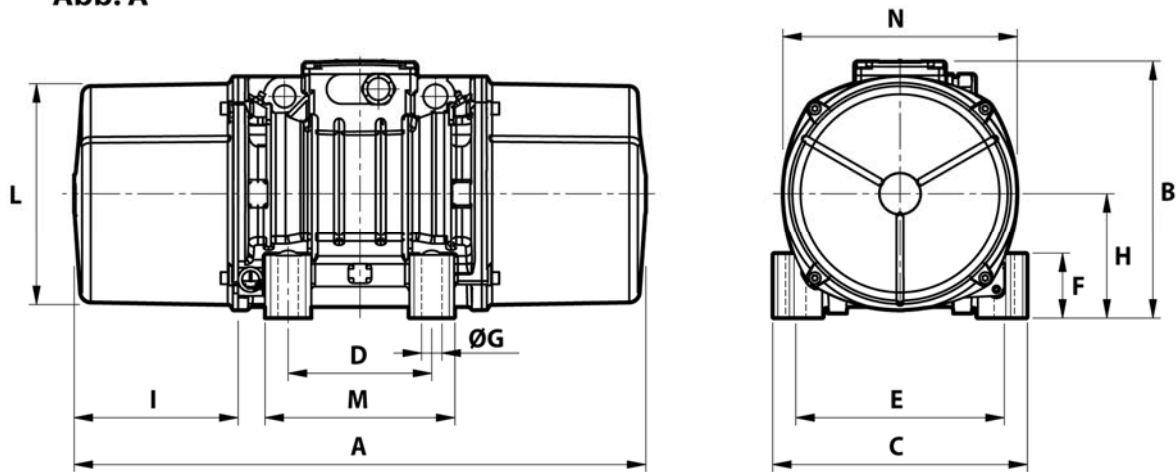

Typ	A	B	C	D	E	F	G	H	I	L	M	N	Kabelverschr.
	[mm]	[mm]	[mm]	[mm]	[mm]	[mm]	[mm]	[mm]	[mm]	[mm]	[mm]	[mm]	
ER-A-900-15	394	216	205	120	170	45	17	93,5	106	170	160	182	M25x1,5

Tabelle 2: Abmessungen