

Micro 21-3 M

Leistungsdaten

- 2-poliger Motor, Nenndrehzahl: 3000 U/min
- Spannung 230V / 50 Hz, 1-Phase
- Anlauf in jeder Position möglich



Typ	Arbeitsmoment	Unwuchtkraft	Leistung	max. Strom	Gewicht
	[kgcm]	[N]	[kW]	[A]	[kg]
Micro 21/3 M	0,40	196	0,04	0,2	2,0

Tabelle 1: Leistungsdaten (bei 400V / 50 Hz)

Abmessungen

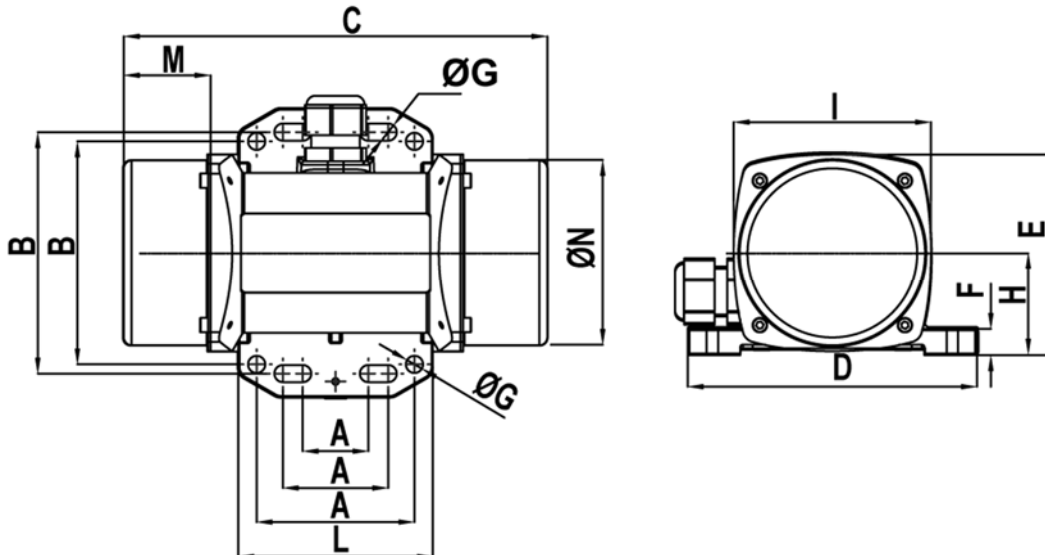

Maß	A	B	C	D	E	F	G	H	I	L	M	N
	[mm]	[mm]	[mm]	[mm]	[mm]	[mm]	[mm]	[mm]	[mm]	[mm]	[mm]	[mm]
Micro 21/3 M	25-40	92	145	110	76,5	10	6,5	39	75	74	25	70,5
	60	85										

Tabelle 2: Abmessungen